



AC INFINITY

AIRFRAME SERIES

CLOSET COOLING SYSTEM

USER MANUAL

WELCOME

Thank you for choosing AC Infinity. We are committed to product quality and friendly customer service. If you have any questions or suggestions, please don't hesitate to contact us. Visit www.acinfinity.com and click [contact](#) for our contact information.

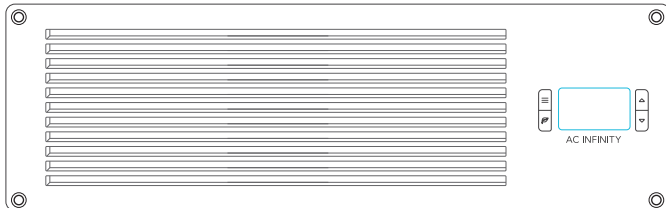
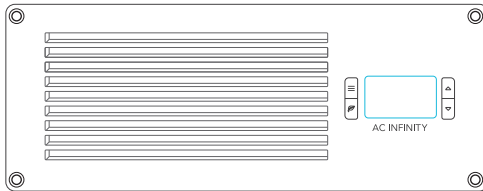

EMAIL

support@acinfinity.com

WEB

www.acinfinity.com

LOCATION

Los Angeles, CA

MANUAL CODE AP1708X1

PRODUCT

AIRFRAME T7
AIRFRAME T7
AIRFRAME T7-N
AIRFRAME T7-N
AIRFRAME T9
AIRFRAME T9
AIRFRAME T9-N
AIRFRAME T9-N

MODEL

AC-AFT7-BE
AC-AFT7-WE
AC-AFT7-BN
AC-AFT7-WN
AC-AFT9-BE
AC-AFT9-WE
AC-AFT9-BN
AC-AFT9-WN

UPC-A

819137020153
819137020160
819137020177
819137020184
854759004068
854759004549
854759004372
854759004389

MANUAL INDEX

Company Contact	Page 3
Manual Index	Page 5
Closet Cooling Guide	Page 6
Key Features	Page 7
Product Contents	Page 8
Installation	Page 9
Filter Maintenance	Page 15
Connecting Additional Fans	Page 17
Controller Programming	Page 18
Other AC Infinity Products	Page 24
Warranty	Page 25

CABINET COOLING GUIDE

INTAKE AND EXHAUST

All cabinet fan systems should contain an intake and an exhaust variable which can either be fans or ventilation holes. This is required to balance the static pressures between the inside and outside room.

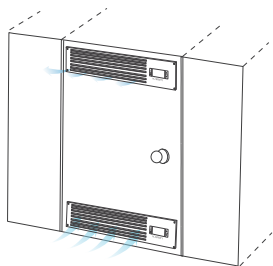

FAN POSITIONING

Due to natural convection, warmer air, which is less dense than colder air, will rise on its own. It is ideal to position fans near the top of the room configured to exhaust out the warmer air and position fans near the lower part of the room to push in colder air.

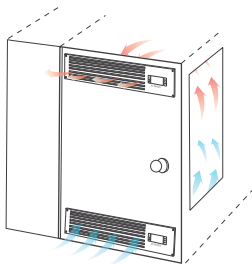

CFM REQUIREMENTS

A fan or set of fan's CFM rating measures the rate at which air flows in of a space. To obtain the required CFM rating, divide the dimensions of a cabinet by 1728 to get the cubic feet area then multiply by three to account for various real world variables.

$$\frac{\text{SIZE OF ROOM}}{1728} \times 3$$

L x W x H (inches)

KEY FEATURES

ALUMINIUM FRAME

Features an aluminium frame with CNC machined corners and edges to give rooms a professional appearance.

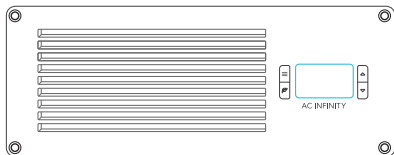

SMART CONTROLLER

Controller enables temp. monitoring, thermal control, speed control, alarms, and SMART energy mode.

DETACHABLE FILTER

A high density filter helps remove dust from entering or exiting the room. Can be easily detached for cleaning.

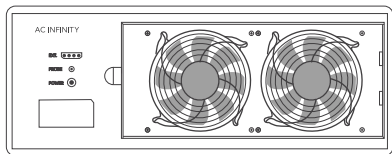
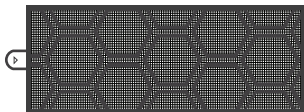

DUAL BALL BEARINGS

Fans contain long-life ball bearings rated at 67,000 hours. Also enables fans to be mounted in any direction.

THERMAL PROBE

The corded sensor probe constructed of stainless steel ensures an accurate temperature reading.

FAN EXPANSION PORTS

Each fan unit contains a port to connect an additional fan unit to share the same controls and power source.

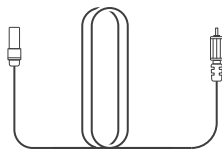

PRODUCT CONTENTS

T-SERIES

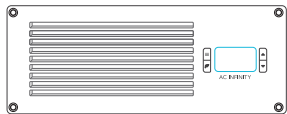

COOLING FAN UNIT (x1)



DETACHABLE FILTER (x1)
(May be on Fan Unit)



THERMAL PROBE (x1)

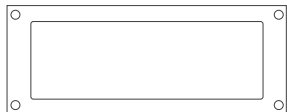

PLASTIC STENCIL (x1)

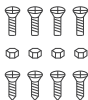

WOOD MOUNTING
SCREW SET (x4)



POWER ADAPTER (x1)

INSTALLATION

STEP 1

Determine where you wish to mount the cooling fan unit onto your door or wall. Position the stencils and apply tape to the outer edges.

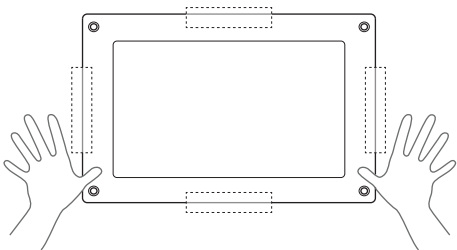

STEP 2

Use a pencil to outline the center square and four outer screw holes on the one stencil. Check for accuracy before proceeding to the next step.

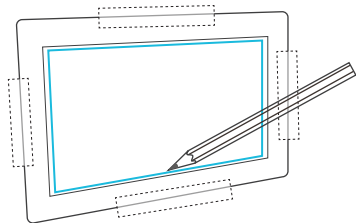

INSTALLATION

STEP 3

Remove the plastic stencil and tape. If you prefer machine screws instead of wood screws to mount the fan and controller, use a power drill to create four screw holes. Recommended drill bit size around 16/64".

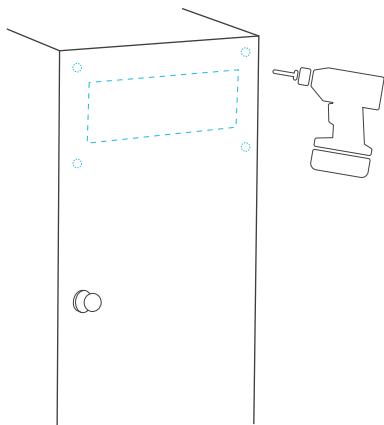

STEP 4

Using a saw, cut out the center piece as outlined by your markings from step one. You may need to first drill a hole at each of the corners to fit your saw through. A power jigsaw may be preferred for thicker wood.

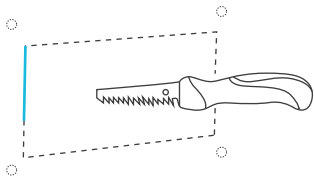

INSTALLATION

STEP 5

Place the fan unit into the newly cut square so that each screw hole is properly aligned. Please make sure that the cut center hole is large enough that the plastic backside of the fan does not come into contact with the cabinet. This is to minimize vibrations which will cause noise.

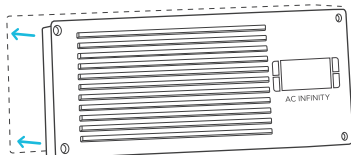

STEP 6

Using the four machine screws, secure the fan unit's frame onto the cabinet or wall. Push each screw through their corresponding hole located on the frame and wall. The included wood screws can also be used instead. Tighten the nuts on the other side.

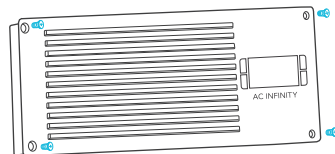

INSTALLATION

STEP 7

After mounting the fan unit onto a door or wall, locate the filter piece. If it has not yet been installed, align and insert the filter piece into the docking holes located on the backside of the fan unit.

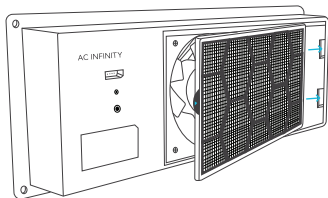

STEP 8

Push the filter piece against the back of the fan unit to click it into position. Please note that using the detachable filter will reduce air performance of the cooling fan unit.

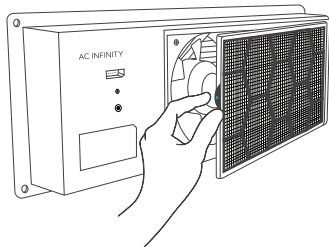

INSTALLATION

STEP 9

To power the fan unit, locate the corded wall adapter. Plug the adapter's connector into the port marked "POWER" located on the backside of the fan unit.

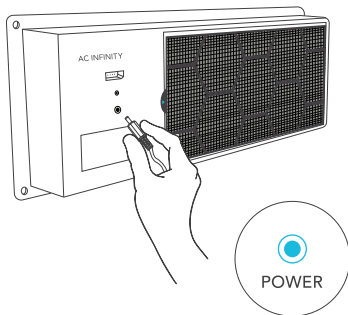

STEP 10

Plug the adapter head into a standard outlet or power strip and check to see if the fan's unit screen is on. You may need to press the leaf button if the unit was previously set to ECO Mode.

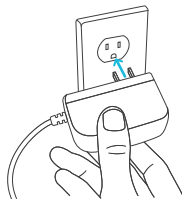

INSTALLATION

STEP 11

To set up temperature readings, locate the corded thermal probe. Plug the probe's connector into the port marked "PROBE" located on the backside of the fan unit.

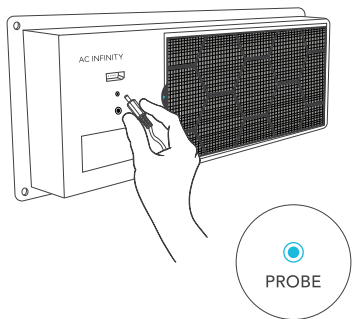

STEP 12

After plugging in the probe, check the fan unit's screen to see that there is now a temperature reading. Position the thermal probe near your devices with the highest temperatures.

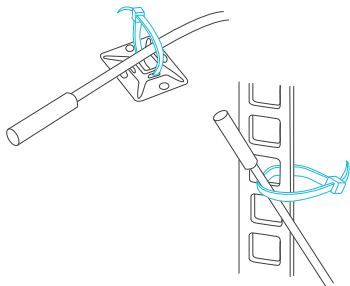

FILTER MAINTENANCE

STEP 1

To detach the filter piece, pull on its lever to release it from the backside of the fan unit. The filter should be cleaned periodically to avoid decreasing the fan's airflow performance.

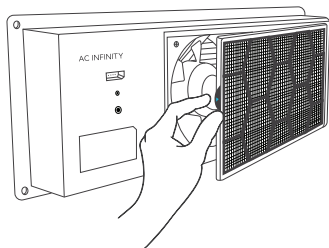

STEP 2

Rinse the filter piece with running water or wipe it down with a damp cloth to remove dust and other particles.

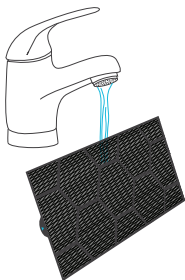

FILTER MAINTENANCE

STEP 3

Wipe down the filter piece thoroughly with a cloth and leave it out to dry. The filter piece should be completely dry before reattaching it to the fan unit.

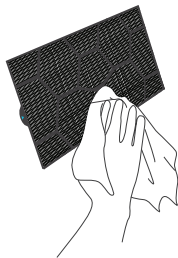

STEP 4

Lastly, push the filter piece against the back of the fan unit to put it back into position.

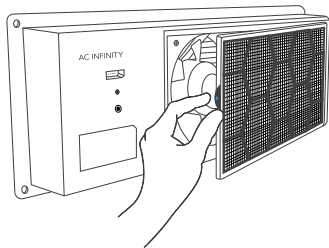

CONNECTING MORE FANS

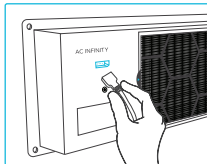

Each T-series fan unit includes a port marked “EXT.” on its backside that enables it to connect one S-series fan unit to share the same smart controls and power source.

FAN EXTENSIONS

S-series fan units connected to the T-series will share the same fan speed and temperature trigger settings. For example, an AIRFRAME T7 exhaust system can control an AIRFRAME S7-N system for intake. If the S-series fan contains an inline speed controller, please make sure their speed is set on high.

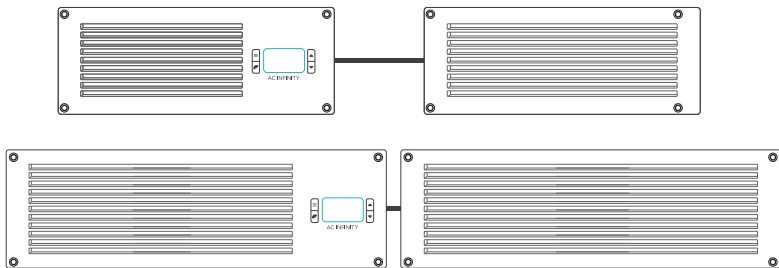

PROGRAMMING

1. MODE BUTTON

Cycles through the modes: AUTO, SMART, SPEED, ALARM, BUFFER. Holding for three seconds will lock or unlock the display.

2. UP / DOWN BUTTON

The up and down buttons changes the setting temp, alarm temp, display brightness, or the speed of the fan.

3. LEAF BUTTON

This turns the display off while programs run in the background. Holding will change degrees to Fahrenheit or Celsius.

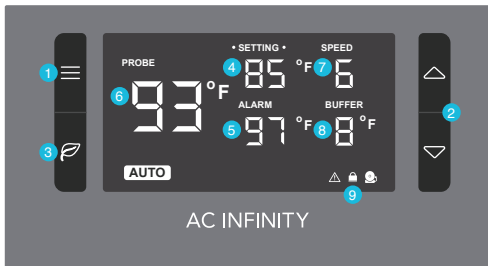

4. SETTING TEMP.

Shows the temperature you set the fans to trigger in AUTO and SMART Mode.

5. ALARM TEMP.

Shows the temperature that you set the fan's alarm system to trigger. Please see page 21 for more information.

6. PROBE TEMP.

Actively shows the current temperature that the probe is measuring.

7. FAN SPEED

Shows what speed the fans are currently running at. Six speeds are available.

8. BUFFER

The buffer range settings of AUTO and SMART Mode programming. Please see page 20 for more information.

9. ALERT ICONS

Flashes to indicate if fan failure, alarm, or display lock is being triggered.

PROGRAMMING

QUICK START

Press the MODE button until you are on AUTO mode. This mode works like a thermostat. Press the up and down triangle buttons to change the SETTING temperature on the screen. The PROBE temperature is what the thermal probe is measuring. When the PROBE temperature exceeds the SETTING temperature, the fans will start running.

SPEED SETTING

In this mode, the fans will run non-stop regardless of temperature. Pressing the up and down buttons while in this mode will change the speed of the fan. Whichever speed is designated in this mode will also be the speed used in AUTO Mode and the max speed of the fans in SMART Mode.

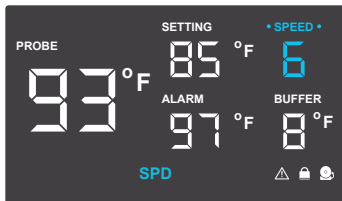

AUTO MODE

This is the thermostat setting where the fans will start running when the PROBE temperature reaches or surpasses the SETTING temperature. The SETTING temperature can be designated by pressing the up and down buttons while in this mode. Once the fans start running, the PROBE temperature will need to fall at least 4° F below the SETTING temp for the fans to stop running. This variation buffer can be changed. Please see page 20 for more information.

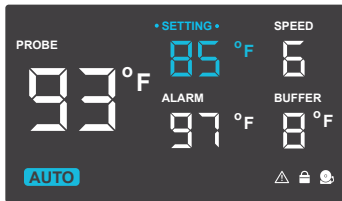

PROGRAMMING

BUFFER SETTING

In AUTO mode, a buffer is built in to prevent your fan from turning on and off too quickly due to small variations in the environment. In SMART mode, there is a range of temperatures between each speed. You can increase or decrease this buffer or range by pressing the up and down buttons.

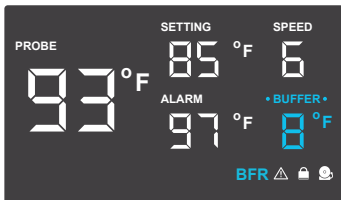

SMART MODE

This is the energy saving mode where the fans will change speed depending on the temperature. The SETTING temperature can be designated by pressing the up and down triangle buttons while in this mode.

For every 4° F increment that the PROBE temperature is below the SETTING temperature, the speed of the fans will decrease by one level. This increment can be changed to 2° F, 6° F, or 8° F by adjusting the Buffer Setting instructed above.

The fan speed you designated in ON Mode will also be the max speed the fan can reach. This occurs when the PROBE temperature reaches or exceeds the SETTING temperature.

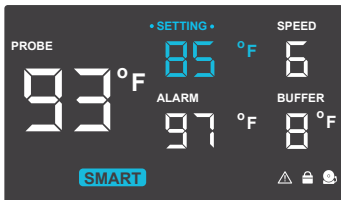

PROGRAMMING

ALARM SETTING

In this mode, you can set what temperature the system's alarm will trigger by pressing the up and down triangle buttons. When the PROBE temperature reaches or exceeds the ALARM temperature, the alarm will activate. The alarm will only activate while the controller is in ON, AUTO, or SMART Mode so please remember to exit ALARM Mode once the alarm has been set. When the alarm is triggered, the fans will run at max speed regardless of the setting and will make an audible beep every three seconds. This will keep occurring until the temperature drops below the ALARM temp. or if any buttons are pressed. The alarm can be disabled by pressing the up triangle button until the temperature is at 140° F, then pressing the up button once more to show "OF".

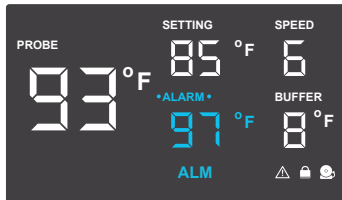

PROGRAMMING

FAHRENHEIT OR CELSIUS

The temperatures displayed can be set to Fahrenheit or Celsius scale by holding the LEAF button until °F or °C is shown after the digits. All digits displayed will be automatically converted to the designated scale.

DISPLAY BRIGHTNESS

To adjust the brightness of the display, hold down the MODE button while pressing the up button repeatedly to increase the brightness. Hold down the MODE button while pressing the down button repeatedly to decrease the brightness. There are three brightness settings available.

CONTROLLER LOCK

Holding the MODE button for three or more seconds will lock the controller. The controller will still work as programmed; however, pressing any buttons will not have an effect and will cause the screen lock icon to flash and will make an audible beep three times per second. This option was designed to prevent your controller settings from being changed by accident. Holding the MODE button again for three or more seconds will unlock the controller.

ECO-DISPLAY

To conserve energy, you can choose to set the display into Eco Mode by pressing the button with a leaf on it to turn the display off. All programs will be operating in the background and fans will still be triggered to run according to the settings. Press any button will turn the display back on.

PROGRAMMING

ALERT ICONS

On the bottom right of the display there are three alert icons. They are visible to show that the system's functions are being monitored. They will flash when the controller wishes to alert you that a particular function is being triggered.

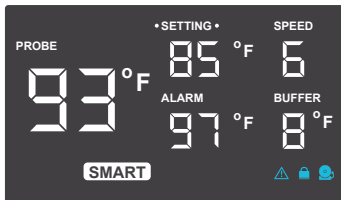

FAN FAILURE ALERT

The fan failure icon will flash when one or more fans in the AIRFRAME cooling system fail. Please see page 25 for contact information regarding fan replacement and exchanges.

DISPLAY LOCK ALERT

This icon is not visible when the controller is unlocked. The icon will flash when any buttons are pressed while the controller is locked. Please see page 22 for more information.

ALARM ALERT

The alarm alert icon will flash when the probe temperature reaches or exceeds the alarm temperature you have set. Please see page 21 for more information on setting up the alarm.



AC INFINITY PRODUCTS

AIRCOM SERIES

The AIRCOM component fan system cools receivers, amplifiers, and other AV components. S-Series models feature a thermal trigger and speed control. T-Series features a LCD digital display with thermal and speed control, alarm alerts, failure triggers, and backup memory.



PRODUCT	MODEL	DIMENSIONS
AIRCOM S6	AI-ACS6	11.6 x 6.3 x 1.5 in.
AIRCOM S7	AI-ACS7	11.6 x 6.3 x 1.5 in.
AIRCOM S8	AI-ACS8	17 x 13.5 x 1.5 in.
AIRCOM S9	AI-ACS9	17 x 13.5 x 1.5 in.
AIRCOM T8	AI-ACT8	17 x 13.5 x 1.5 in.
AIRCOM T9	AI-ACT9	17 x 13.5 x 1.5 in.

CLOUDPLATE SERIES

The CLOUDPLATE rack fan system is designed for quietly cooling a wide range of audio video, home theater, DJ, server, network, and IT equipment racks. Features a thermal controller that will automatically adjust duct fan speeds in response to changing temperatures.



PRODUCT	MODEL	RACK SIZE
CLOUDPLATE T1	AI-CPT1	1U
CLOUDPLATE T1-N	AI-CPT1-N	1U
CLOUDPLATE T7	AI-CP2L	2U
CLOUDPLATE T7-N	AI-CP2H	2U
CLOUDPLATE T9	AI-CPT9	3U
CLOUDPLATE T9-N	AI-CPT9-N	3U

WARRANTY

This warranty program is our commitment to you, the original purchaser, that each product sold by AC Infinity will be free from defects in manufacturing for a period of two years from the date of purchase. If a product is found to have a defect in material or workmanship, we will take the appropriate actions defined in this warranty to resolve any issues.

The warranty program applies to any order, purchase, receipt, or use of any products from AC Infinity. The program covers products that have become defective, malfunctioned, or expressly if the product becomes unusable. The warranty program goes into effect on the date of purchase. The program will expire two years from the date of purchase. If your product becomes defective during that period, AC Infinity will replace your product with a new one or issue you a full refund.

The warranty program does not cover abuse or misuse. This includes physical damage, submersion of the product in water, incorrect Installation such as wrong voltage input, and misuse for any reason other than intended purposes. AC Infinity is not responsible for consequential loss or incidental damages of any nature caused by the product. We will not warrant damage from normal wear such as scratches and dings.



If you are not 100% satisfied with this product, we will be happy to replace it or issue you a full refund. Please contact us!

COPYRIGHT © 2017 AC INFINITY INC. ALL RIGHTS RESERVED

No part of the materials including graphics or logos available in this booklet may be copied, photocopied, reproduced, translated or reduced to any electronic medium or machine readable form, in whole or in part, without specific permission from AC Infinity Inc.

www.acinfinity.com