

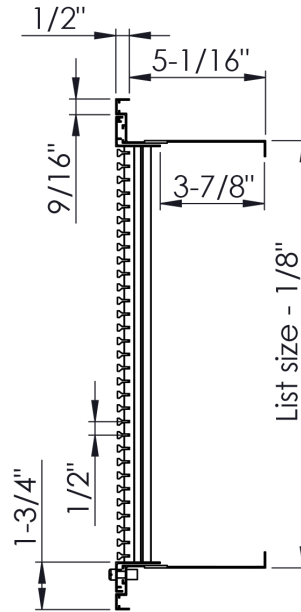

- Complements the appearance of our Bar Linear grilles.
- Fully-extruded, architectural aluminum construction.
- Fixed blades parallel to the length.
- Designed to fit a standard 4" filter depth.
- Available on 2" increments as standard. Custom sizes available down to 1/16" increments.
- Available with durable powder coat finish.

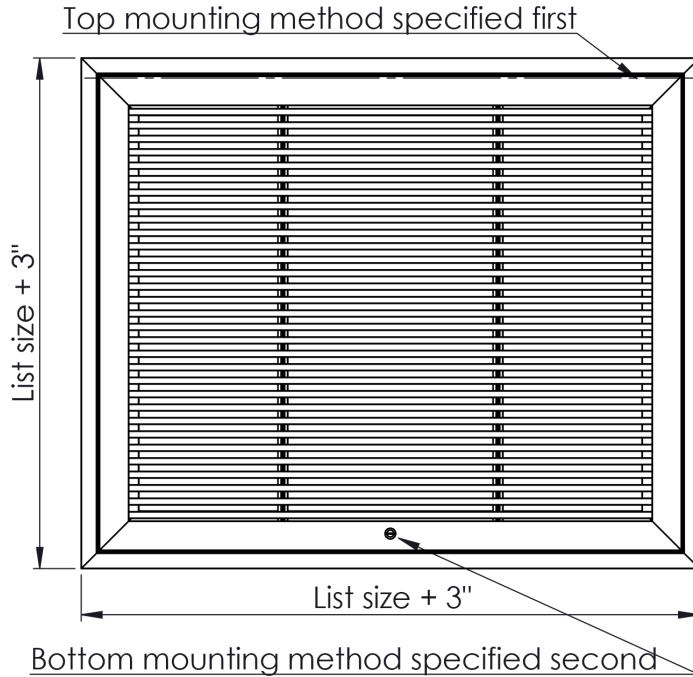

*4" filter by others must be undersized by list-9/32".*

**1. Select a Blade Option**

- 00 - 0° Deflection
- 01 - 0° Pencil Proof
- 15 - 15° Deflection
- 30 - 30° Deflection
- 82 - 0° Air Flow
- 84 - 0° Heel Proof

**2. Select a Top Mounting Option**

- B - Wire Hinge
- C - Nylon Thumb Screw
- D - Nylon Screen Tabs
- E - Security Screw

**3. Select a Bottom Mounting Option**

- C - Nylon Thumb Screw
- D - Nylon Screen Tabs
- E - Security Screw

**4. Specify the Length x Height Dimensions**

Inches  MM \_\_\_\_\_ x \_\_\_\_\_

**5. Select a Finish**

- W - White
- S - Silver
- M - Mill

**6. Select a Lead Time**

- 3 Day Ship
- Next Friday
- Standard Delivery

Qty \_\_\_\_\_



Project / Location: \_\_\_\_\_  
 Architect: \_\_\_\_\_  
 Engineer: \_\_\_\_\_  
 Contractor: \_\_\_\_\_



## BLADE OPTIONS

**-00**

0° 13/64" blades on 1/2" centers

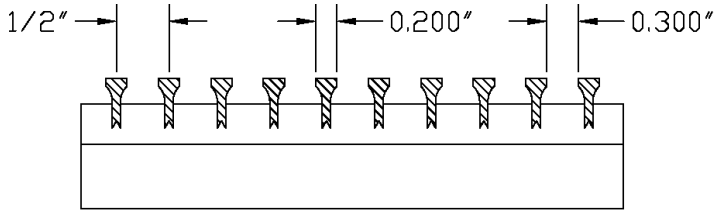

**-01**

0° 1/4" blades on 1/2" centers

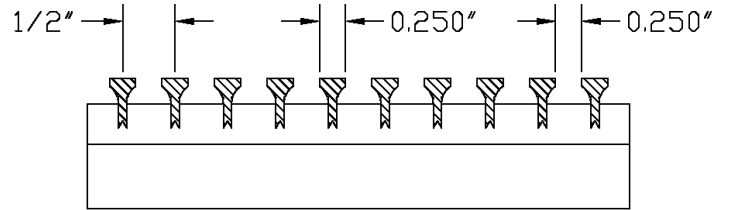

**-15**

15° 13/64" blades on 1/2" centers

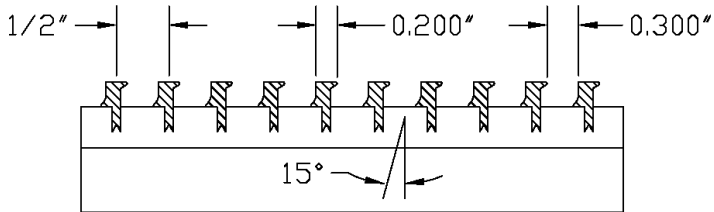

**-30**

30° 13/64" blades on 1/2" centers

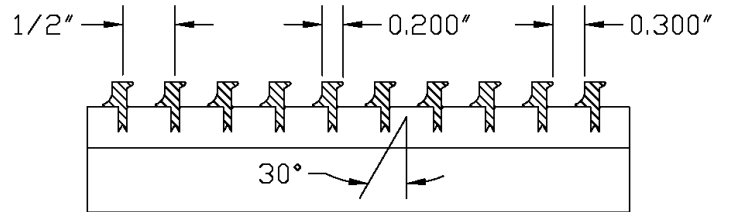

**-82**

0° 1/8" blades on 1/2" centers

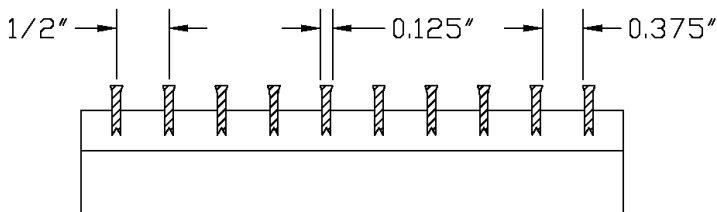

**-84**

0° 1/8" blades on 1/4" centers

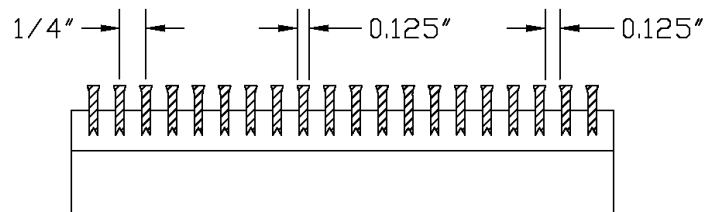

## MOUNTING

Both a top & bottom mounting option is required for securing the grille to the outer frame.

Wire Hinge

**B**

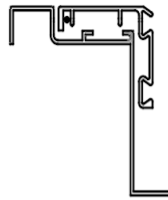
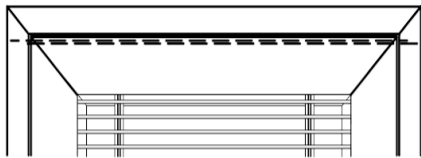

**B - Wire Hinge** mounting is for hinged access only, and grille face is connected to the outer filter frame.

**B - Wire Hinge** is only available for top mounting.

Nylon Thumb Screw

**C**

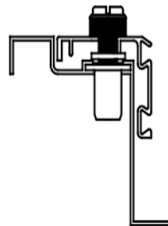
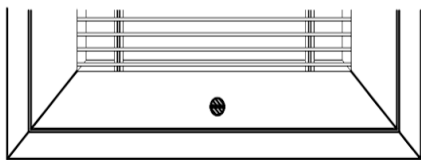

**C - Nylon Thumb Screw**

Nylon Screen Tabs

**D**

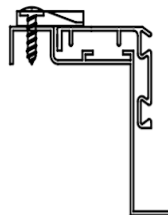
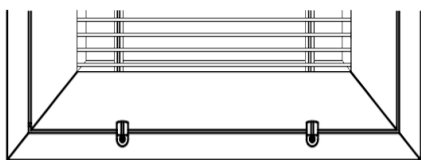

**D - Nylon Screen Tab**

Security Screw

**E**

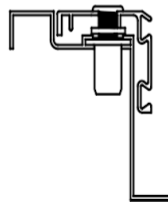
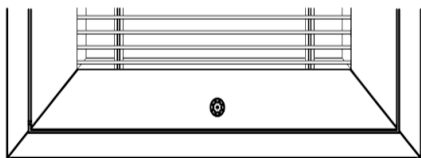

**E - Security Key** bit is required for access. The security key is available separately for order as a FG-KEY.