

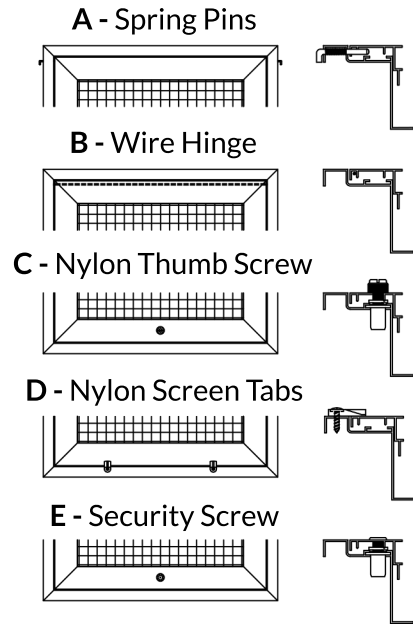

- 1/2" x 1/2" x 1/2" aluminum eggcrate core.
- Designed to fit a standard 4" filter depth.
- High quality aluminum extruded frames.
- Available on 2" increments as standard. Custom sizes available down to 1/16" increments.
- Available with durable powder coat finish.

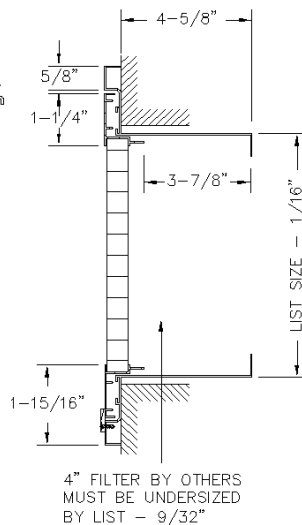
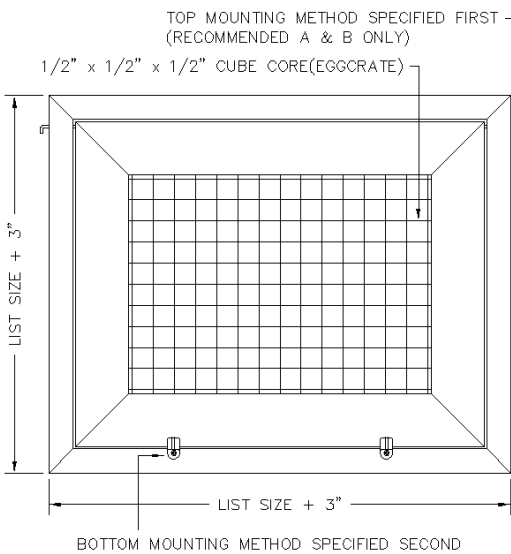

A - Spring Pin mounting allows for easy hinged access and fully removable grille face from outer filter frame.

B - Wire Hinge mounting is for hinged access only, and grille face is connected to the outer filter frame.

E - Security Key bit is required for access. The security key is available separately for order as a FG-KEY.

1. Select a Top Mounting Option

- A - Spring Pins
- B - Wire Hinge
- C - Nylon Thumb Screw
- D - Nylon Screen Tabs
- E - Security Screw

2. Select a Bottom Mounting Option

- A - Spring Pins
- B - Wire Hinge
- C - Nylon Thumb Screw
- D - Nylon Screen Tabs
- E - Security Screw

3. Specify the Length x Height Dimensions

Inches MM _____ x _____

4. Select a Finish

- W - White
- S - Silver
- M - Mill

5. Select a Lead Time

- 3 Day Ship
- Next Friday
- Standard Delivery



Additional Options

- D - Opposed Blade Damper

Project / Location: _____
 Architect: _____
 Engineer: _____
 Contractor: _____

